

S1150 & S1250 Series Exit Devices

Classic Product

Certification & Compliance:

- ANSI/BHMA A156.3, Grade 1
- ANSI A117.1 Accessibility Code
- Underwriters Laboratories (UL and CUL) listed for accident hazard (panic) standard.
- Fire Exit hardware for hollow metal doors, UL and CUL listed for 3 hour, A label and lesser doors, Prefix "F" before part number.
- Fire Exit hardware for wood doors, listed up to 1-1/2 hour, B label doors.
- All exit devices comply with life safety code NFPA 101.
- All fire rated devices comply with fire door and window code NFPA80.



S1150
Vertical Rod Exit Device

S1250
Rim Exit Device

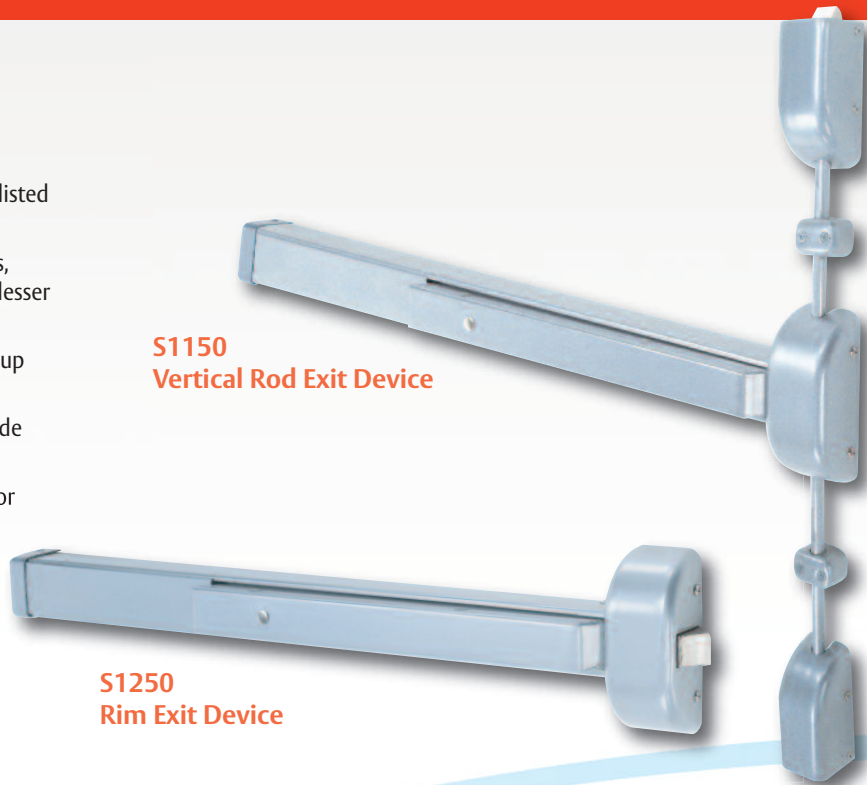

General Specifications:

	S1150	S1250
Chassis & Cover	Non-ferrous alloy	Non-ferrous alloy
End caps	Metal	Metal
Doors	1-3/4" (44.45mm) thick wood or hollow metal 3-3/4" minimum stile for single doors 3-1/2" (88.90mm) minimum stile for double doors	1-3/4" (44.45mm) thick wood or hollow metal 4-1/2" (114.3mm) minimum stile 4-5/8" for fire-labeled devices
Handing	Reversible	Reversible
Dogging	Allen-type key standard, cylinder available.	Allen-type key standard, cylinder available.
Top/Bottom Bolts/ Latchbolt	Brass 1/2" (12.7mm) throw top, 3/4" (19.05mm) bottom	3/4" (19.05mm) throw, stainless steel
Throughbolts	Order separately	Order separately
Rail Assembly	Steel	Steel
Rail Size	Furnished standard for doors up to 36", can be cut down to accommodate 32" doors. Alternate rail sizes available for narrow or wide doors	Furnished standard for doors up to 36", can be cut down to accommodate 32" doors. Alternate rail sizes available for narrow or wide doors
Rods	90°-extension kits available	N/A
Trim	See trim page 113	See trim page 113
Finishes	AL, BRZ, LBZ (sprayed finishes)	AL, BRZ, LBZ (sprayed finishes)

S1150 & S1250 Series Exit Devices

Classic Product

Strikes – S1150 Series:

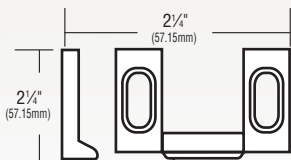

Standard Top Strike - S22

S22 top strike surface applied to stop, no mortise required. Black nylon coated, furnished standard.

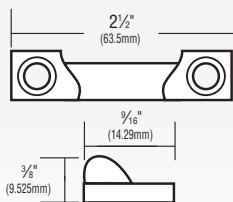

Standard Bottom Strike - S23

S23 bottom Strike surface applied to threshold or floor. Black nylon coated, furnished standard.

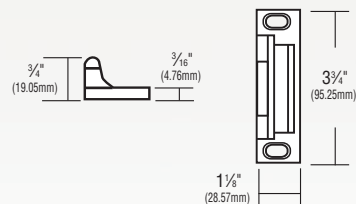

Fire Rated Top Strike - 646

Standard for FS1150. Surface applied. Nylon Coated.

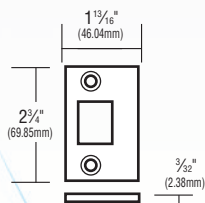

Fire Rated Bottom Strike - S655

Standard for FS1150. Flush mounted, stainless steel. Furnished with expansion shields.

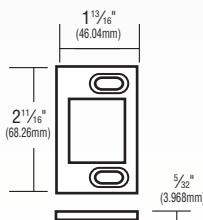

Sliding Bottom Bolt - S43

Alternate bottom strike for SVR.

Strikes – S1250 Series:

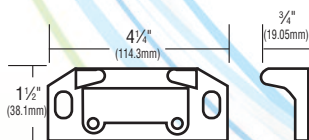

Fire Rated Surface Strike - S24

Surface applied nylon coated for fire labeled S1250

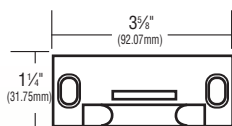

Standard Surface Strike - S38

Surface applied furnished standard.

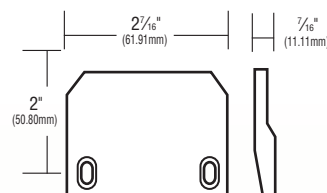

Double Door Strike - S36

Strike for double doors without mullion.

Parts:

Chassis Covers, End Caps & Dogging Key

	Part No.
Chassis cover for 1150	28-0018
Chassis cover for 1250	28-0013
End cap for 1150 & 1250	28-0012
End cap mounting bracket	68-0080
Dogging Key	97-0001

Rail Assemblies – Standard Rail, Sprayed Finish

24" - 32" Doors	PR-24
32-1/4" - 36" Doors	PR-36
36-1/4" - 48" Doors	PR-48
Add "F" prefix for fire rated	

Rail Assemblies – Rail with Cylinder Dogging, Sprayed Finish

24" - 32" Doors	PR-24 CD
32-1/4" - 36" Doors	PR-36 CD
36-1/4" - 48" Doors	PR-48 CD

Extension Rod Kit for S1150 Series

18 inch	VRX-18
24 inch	VRX-24

S1150 & S1250 Series Exit Devices

Classic Product

S1150 & S1250 Exit Device Trim:

Matching trim available to complement other series of cylindrical locks, B Series Mortise locks, exit devices and alarms.

Functions:

01: Passage

12: Storeroom—Key retracts latch, only removable when locked.

17: Classroom—Key locks/unlocks outside knob/lever.

Ordering Information:

When ordering trim, specify design symbol and function, eg: **BR12**, if specifying **Broadway** lever in **Storeroom** function.

Finish:

US3, US4, US10, US10B, US26, US26D. (Knobs and levers)

AL, BRZ, RD. (SF Trim)

Lever Trim:

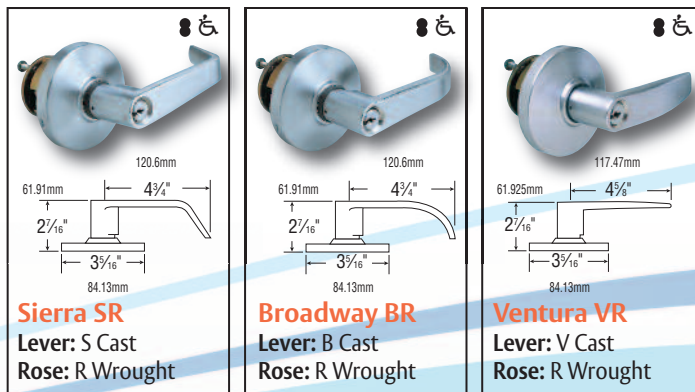

Knob Trim:

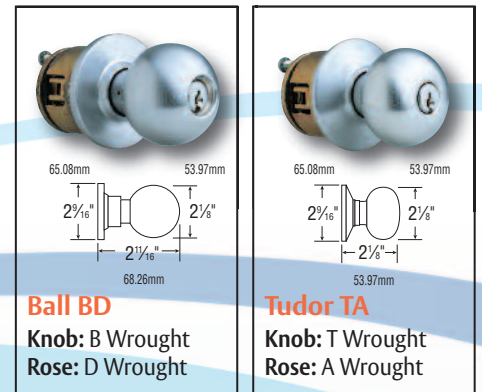
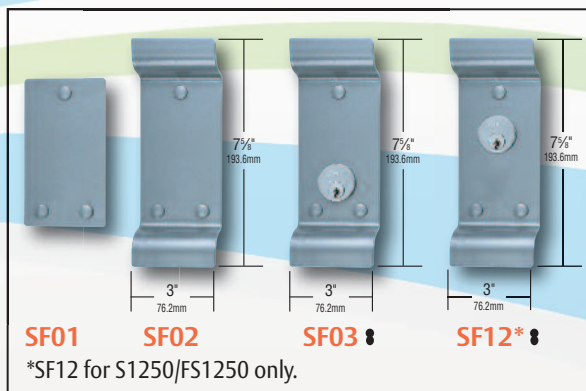

Plate Trim:



Lever Trim Cover Plate:



1000, 3000, 4000 Series Exit Devices

Classic Product

Arrow 1000, 3000 & 4000 Series Exit Device Trim:

Optional Slip-Clutch Lever Design

- Optional slip-clutch is built in beneath security collar added to shank of lever.
- Available for use with SL88, SL33 and SL08 exit device trim for 1000 and 3000 Series Exit Devices. (Not available for S1150 or S1250 Series devices.)
- 

Vandal-resistant slip-clutch lever releases when excessive force is applied without retracting latch. Easily reset by returning lever to horizontal position.

Exit Device Trim Functions:

Function	1700/1700-FR	1800/1800-FR	1900/1900-FR
02*	SP, SS, SB, SN	SP, SS, SB, SN, SL	SP, SS, SB, SN, SL
03	N/A	SP, SS, SB, SN, SL	SP, SS, SB, SN, SL
05	SP, SS, SB, SN	SP, SS, SB, SN	SP, SS, SB, SN
05A	SP, SS, SB, SN	SP, SS, SB, SN	SP, SS, SB, SN
08	SL	SL	SL
08A	SL	SL	SL
11	S311	N/A	N/A
12	S312	N/A	N/A

Function	3600/3600-FR	3700/3700-FR	3800/3800-FR	3900/3900-FR
02*	SL	SP, SS, SB, SN, SL	SP, SS, SB, SN, SL	SP, SS, SB, SN, SL
03	N/A	N/A	SP, SS, SB, SN, SL	SP, SS, SB, SN, SL
05	N/A	SP, SS, SB, SN	SP, SS, SB, SN	SP, SS, SB, SN
05A	N/A	SP, SS, SB, SN	SP, SS, SB, SN	SP, SS, SB, SN
08	SL	SL	SL	SL
08A	SL	SL	SL	SL
11	S411	S311	N/A	N/A
12	S412	S312	N/A	N/A

Function	4600/4600*-FR	4800	4900/4900-FR
02*	SL	SS, SL	SS, SN, SL
03	N/A	SS, SL	SS, SN, SL
05	N/A	N/A	SS, SN
05A	N/A	N/A	SS, SN
08	SL	SL	SL
08A	SL	SL	SL
11	S511/UL-S411	N/A	N/A
12	S512/UL-S412	N/A	N/A

*02 not available fire rated.

Order Example:

Example: To order.

Specify:

Standard:

38
Series

88
Function

SL
Outside Trim
(If Applicable)

26D
Outside Finish

F
Rail Size

32D
Push Bar Finish

RR
Handing

xxx
Options
(If Required)

Exit Device Type:

ANSI TYPE	ARROW DEVICE	
Type 1	Rim	S1250, 1800, 3800
Type 2	Surface Vertical Rod	S1150, 1700, 3700
Type 3	Mortise	1900, 3900
Type 4	Narrow Stile Rim	4800
Type 6	Narrow Stile Concealed Vertical Rod	4600
Type 8	Metal Door Concealed Vertical Rod	3600
Type 10	Narrow Stile Mortise	4900
Type 22	Removable Mullion	S20, S21

Exit Device Function:

ANSI ARROW FUNCTION	
01 Exit only; no outside trim	01, 03
02 Entry by trim when actuating bar is locked	01, 02, 03
03 Entry by trim when latchbolt retracted by key. Key removable only when trim is locked.	03
05 Entry by thumbpiece when thumbpiece locked/unlock by key.	05
05A Entry by thumbpiece; thumbpiece always operative, no outside cylinder.	5A
08 Entry by knob/lever; outside key locks, unlocks knob/lever.	08
08A Entry by knob/lever; outside knob/lever always operative.	08A
11 Entry by auxiliary control turnpiece key locks, unlocks control.	11
12 Entry by auxiliary control turnpiece only when released by turning key. Key removable only when locked.	12

Mullions & Accessories Series Exit Devices

Mullions & Accessories:

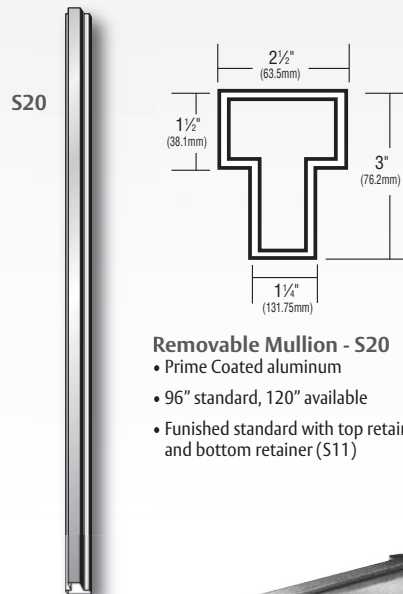

Removable Mullion - S20

- Prime Coated aluminum
- 96" standard, 120" available
- Finished standard with top retainer (S10) and bottom retainer (S11)



S3000 Dummy Rail

A non-functioning rail assembly for use on double doors. Matches S3000 and S4000 series exit devices. Available in sizes 24 (for 24"-29" doors), 36 (for 30"-36" doors), 48 (for 37"-48" doors). Bars can be cut down in the field. For stile width under 4-1/2", specify next larger size. Available in finishes - 3, 4, 10, 10B, 32, 32D, AL, BRZ.

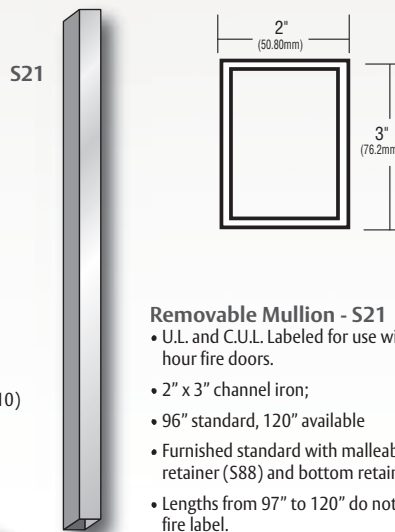

Removable Mullion - S21

- U.L. and C.U.L. Labeled for use with 3 hour fire doors.
- 2" x 3" channel iron;
- 96" standard, 120" available
- Furnished standard with malleable iron top retainer (S88) and bottom retainer (S89).
- Lengths from 97" to 120" do not carry U.L. fire label.



Cylinder Dogging Rail

- Optional cylinder dogging available

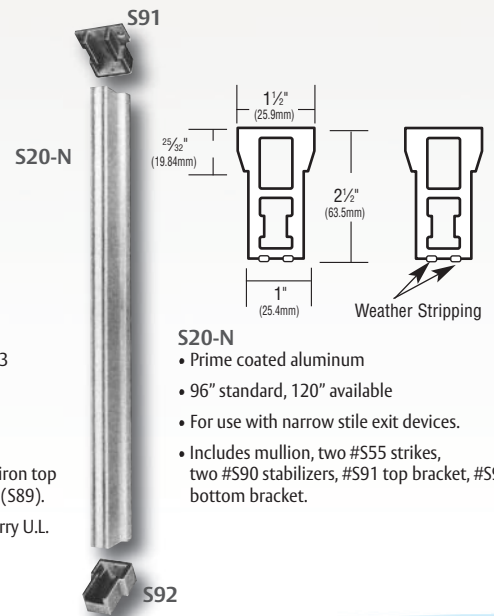

S20-N

- Prime coated aluminum
- 96" standard, 120" available
- For use with narrow stile exit devices.
- Includes mullion, two #S55 strikes, two #S90 stabilizers, #S91 top bracket, #S92 bottom bracket.



VRX-18 Rod Extension

- Prime Coated aluminum
- 96" standard, 120" available
- Furnished standard with top retainer (S10) and bottom retainer (S11)

Mullions:

Description	Part No.
Removable mullion - 96"	S20
Removable Mullion - 120"	S20-120
Key removable mullion - 96", less cylinder	S20-K
Removable mullion for narrow stile - 96"	S20-N
Removable mullion for narrow stile - 120"	S20-N-120
Fire-rated removable mullion - 96"	S21
Fire-rated key removable mullion - 96", less cylinder	S21-K
Top retainer for S20	S10
Bottom retainer for S20	S11
Top retainer for S20-N	S91
Bottom retainer for S20-N	S92
Stabilizer for S20-N	S90
Top retainer for S21	S88
Bottom retainer for S21	S89

Fire Labeled Hardware Exit Devices

Selection chart for A through E labeled doors

For reference only. Refer to latest UL building materials list for complete information.

Application	Type	Narrow Device	Standard Device	Maximum Door Opening
Single Door	Rim	—	FS1250 1800-FR 3800-FR	4'0" x 8'0"
	Mortise	4900-FR	1900-FR 3900-FR	4'0" x 8'0"
Double Doors with S21 Mullion	Rim	—	FS1250 x FS1250 1800-FR x 1800-FR 3800-FR x 3800-FR	8'0" x 8'0"
	Mortise x concealed vertical rod	4900-FR x 4600-FR	3900-FR x 3600-FR	8'0" x 8'0"
Double Doors without Mullion	Mortise x surface vertical rod	—	1900-FR x 1700-FR 3900-FR x 3700-FR	8'0" x 8'0"
	Two concealed vertical rod	4600-FR x 4600-FR	3600-FR x 3600-FR	8'0" x 8'0"
	Two surface vertical rod	—	FS1150 x FS1150 1700-FR x 1700-FR 3700-FR x 3700-FR	8'0" x 8'0" (B-E)
Double Egress Doors	Two concealed vertical rod	4600-FR x 4600-FR	3600-FR x 3600-FR	8'0" x 7'2" (A) 8'0" x 8'0" (B-E)
	Two surface vertical rod	—	FS1150 x FS1150 1700-FR x 1700-FR 3700-FR x 3700-FR	8'0" x 7'2" (A) 8'0" x 8'0" (B-E)

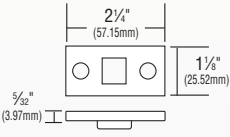
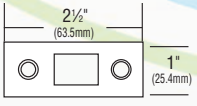
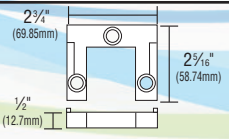
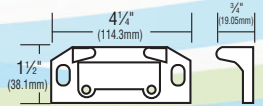
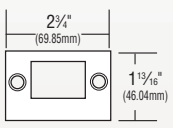
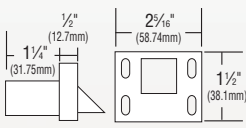
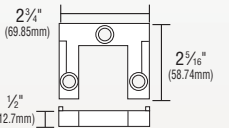
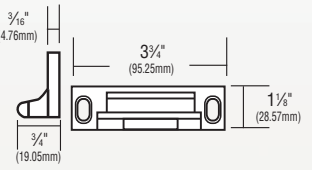



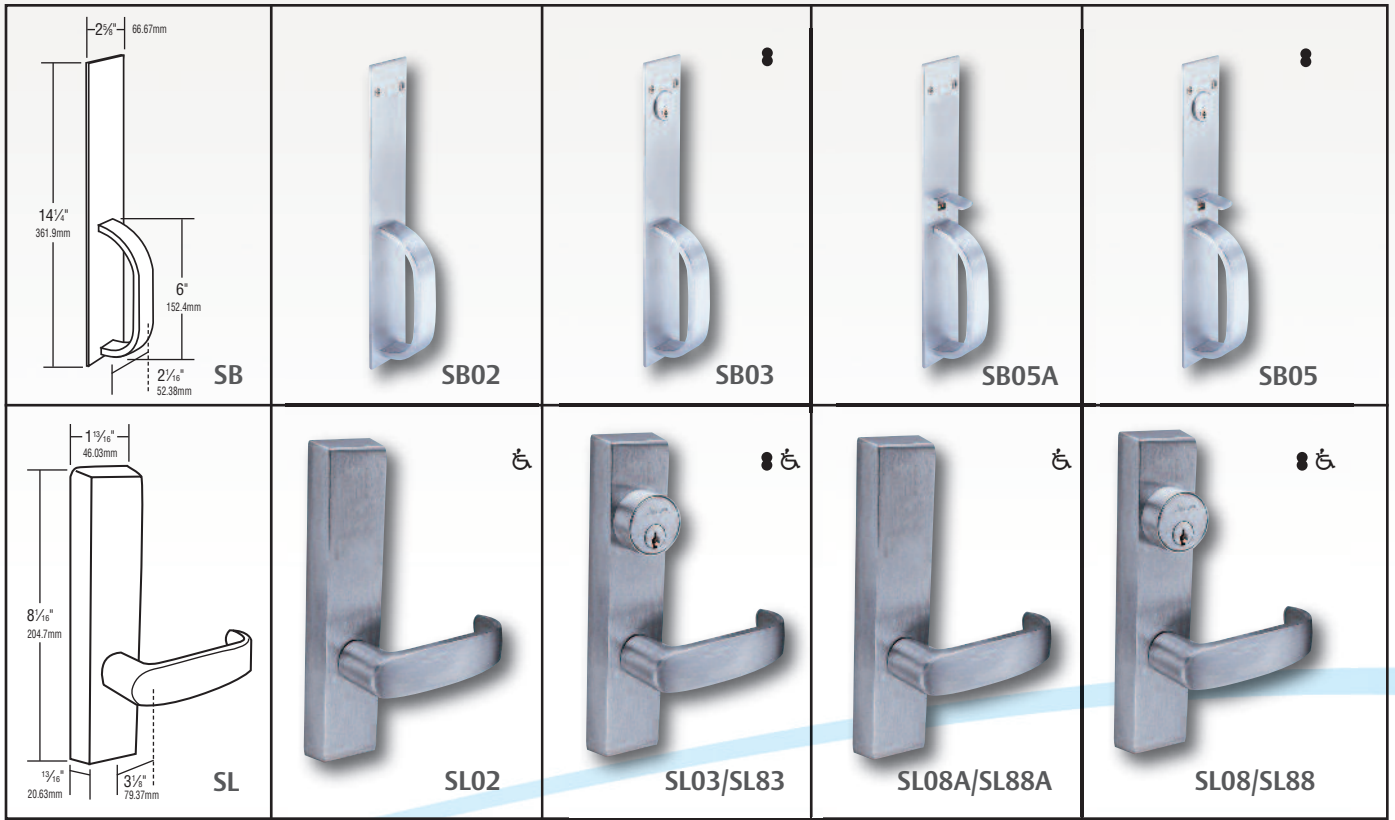







 <p>S13 Bottom Strike Stainless steel. Furnished with expansion shields. Stainless steel.</p>	 <p>S14 For application to wood or hollow metal doors.</p>	 <p>S15 Bottom Strike Alternate for 1700-FS. For use on 1/2" threshold. Stainless steel. Furnished with expansion shields.</p>	 <p>S24 F-400 Series standard for single door applications. Black nylon coated.</p>
 <p>S45 Standard for F-S1700. Flush mounted. Stainless steel. Furnished with expansion shields.</p>	 <p>S46 Bottom Strike Standard for F-S1150, F-S3700. Flush mounted. Furnished with expansion shields. Stainless steel, black nylon coated.</p>	 <p>S58 Bottom Strike Alternate for F-S1150, 3700-FS. For use on 1/2" threshold. Stainless steel, nylon coated. Furnished with expansion shields.</p>	 <p>646 Fire Rated Top Strike Standard for FS1150 and 3700-FR. Surface applied. Nylon Coated</p>

Exit Device Trim



ASSA ABLOY, the global leader in door opening solutions

Exit Device Trim

	<p>Auxiliary Outside Control</p>	 <ul style="list-style-type: none"> • S311—Use with S3700, FS3700, S1700, FS1700. Key locks or unlocks turn lever. • S312—Use with S3700, FS3700, S1700, FS1700. Turn lever operative only with key in cylinder and turned. • S411—Use with S3600, FS3600, FS4600. Key locks or unlocks turn lever. • S412—Use with S3600, FS3600, FS4600. Turn lever operative only with key in cylinder and turned. • S511—Use with S4600. Key locks or unlocks turn lever. • S512—Use with S4600. Turn lever operative only with key in cylinder and turned. 		
<p>SP</p>	 <p>SP02/SP82</p>	 <p>SP03/SP83</p>	 <p>SP05A</p>	 <p>SP05</p>
<p>SS</p>	 <p>SS02/SS82</p>	 <p>SS03/SS83</p>	 <p>SS05A</p>	 <p>SS05</p>
<p>SN</p>	 <p>SN02/SN82</p>	 <p>SN03/SN83</p>	 <p>SN05A</p>	 <p>SN05</p>

Exit Device Selection Chart

For reference only. Refer to latest UL building materials list for complete information.

Application	Type	Narrow Stile Touch Bar	Standard Touch Bar	Crossbar
Single Door	Rim	4800	S1250, FS1250 3800, 3800-FR	1800, 1800-FR
	Vertical Rod	—	S1150, FS1150 3700, 3700-FR	Mortise
	Concealed Vertical Rod	4600, 4600-FR	3600, 3600-FR	Mortise
	Mortise	4900, 9600-FR	3900, 3900-FR	Mortise
Double Doors with Mullion	Rim	4800 x 4800 with S20-N mullion	S1250 x S1250 3800 x 3800 with S20 mullion FS1250 x FS1250 3800-FR x 3800-FR with S21 mullion	Mortise
Double Doors without Mullion	Concealed Vertical Rod	4600 x 4600 4600-FR x 4600-FR	3600 x 3600 3600-FR x 3600-FR	Mortise
	Vertical Rod	—	S1150 x S1150 FS1150 x FS1150 S3700 x S3700 3700-FR x 3700-FR	Mortise
	Vertical Rod x Mortise	—	3700 x 3700 3700-FR x 3700-FR	Mortise